



MATERIAŁY BUDOWLANE

Building Materials





z siedzibą w Zgórsku to firma rodzinna powstała w 1976 roku. Produjemy wyroby budowlane (narożniki i listwy do tynkowania oraz ocieplania ścian, elementy konstrukcyjne sufitów podwieszanych i lekkich ścian działowych, klapy i drzwiczki rewizyjne), energetyczne (konstrukcje do linii średniego i niskiego napięcia, śruby hakowe, zaciski), instalacji odgromowych (sondy, maszty odgromowe, złączki, zaciski).

Wykonujemy szeroki zakres usług (obróbka skrawaniem, obróbka plastyczna, obróbka precyzyjna, obróbka EDM, usługi spawalnicze).

Projektujemy maszyny, urządzenia, narzędzia.

Dynamiczny rozwój firmy oraz wysoka jakość produkowanych wyrobów umożliwiły podjęcie długookresowej współpracy z wieloma partnerami zarówno krajowymi jak i zagranicznymi.

Produkowane przez nas wyroby posiadają znak CE, potwierdzający zgodność z normami europejskimi, znak budowlany, potwierdzający przydatność do stosowania w budownictwie, dlatego dostępne są w sieciach sprzedaży wiodących dystrybutorów na całym świecie

Wysoką jakość produktów gwarantują prowadzone badania oraz Krajowe Oceny Techniczne wydane przez Instytut Techniki Budowlanej – Jednostka Notyfikowana nr 1488, jednostka akredytowana i certyfikowana.

Działalność firmy DELKAR oparta jest na zasadach społecznej odpowiedzialności biznesu, co zostało potwierdzone poprzez przyznanie certyfikatów i srebrnych medali CSR przez niezależną międzynarodową agencję ratingową.

Zapraszamy do współpracy.



based in Zgórsko is a family company established in 1976. We produce construction products (corners and strips for plastering and wall insulation, structural elements of suspended ceilings and lightweight partition walls, hatches and inspection doors), energy products (structures for medium and low voltage lines, hook screws, clamps), lightning protection installations (probes, masts lightning protection, connectors, clamps).

We provide a wide range of services (machining, plastic processing, precision machining, EDM machining, welding services).

We design machines, devices and tools.

The dynamic development of the company and the high quality of manufactured products have enabled long-term cooperation with many partners, both domestic and foreign.

















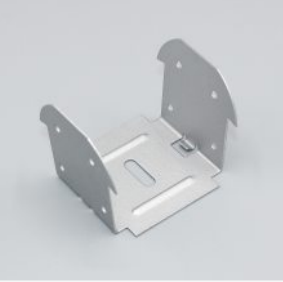

















The products we produce have the CE mark, confirming compliance with European standards, and a construction mark confirming their suitability for use in construction, which is why they are available in the sales networks of leading distributors around the world.

The high quality of the products is guaranteed by research and National Technical Assessments issued by the Building Research Institute - Notified Body No. 1488, an accredited and certified body.

DELKAR's operations are based on the principles of corporate social responsibility, which has been confirmed by the awarding of CSR certificates and silver medals by an independent international rating agency.

We invite you to cooperate with us.

SPIS TREŚCI

					6
					7
					8
					9
					10
					11
					12

13



14



15



16



17



18



19







Element do mocowania ES płaski do profili CD60 Fixing element-flat ES for profiles CD60

Długość ramion | Length of the arm: 75, 125, 150, 175, 200, 225, 250, 300 [mm]

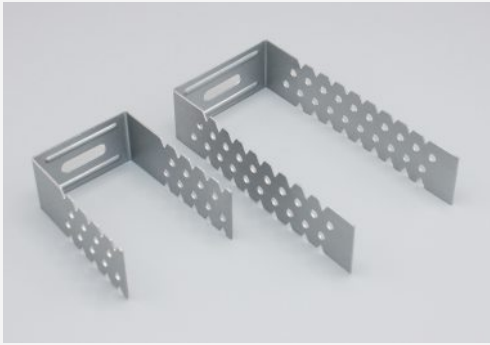

Element do mocowania ES gięty do profili CD60 Fixing element ES bent for profiles CD60

Długość | Length: 75, 125 [mm]



Wieszak do poddaszy do profili CD60 Suspension member for attics for profiles CD60

Długość | Length: 30, 45, 60, 90 [mm]



Wieszak do poddaszy do profili CD60 Suspension member for attics for profiles CD60

Długość | Length: 180, 250, 300, 350, 400, 450, 500 [mm]



Łącznik krzyżowy do profili CD60 Cross connector flat for profiles CD60

Łącznik krzyżowy płaski do profili CD60
Cross connector flat for profiles CD60



Łącznik krzyżowy gięty do profili CD60
Cross connector bent for profiles CD60



Łącznik krzyżowy 60/60 do profili CD60
Cross connector 60/60 for profiles CD60



Łącznik krzyżowy CD 60/UA 50
Cross connector CD 60/UA 50



Łącznik wzdłużny do profili CD60
Longitudinal connector for profiles CD60

Długość | Length: 80, 110 [mm]





Łącznik poprzeczny jednostronny do profili CD60
Crosswise one-sided connector for profiles CD60

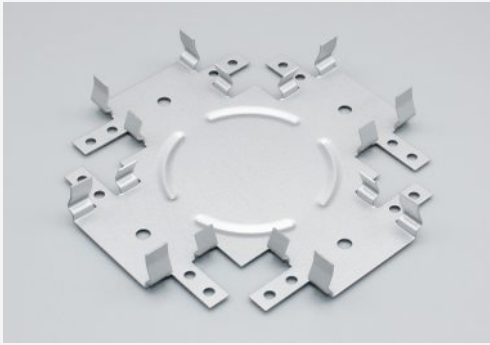

Łącznik poprzeczny dwustronny krab do profili CD60
Crosswise two-side connector (crab) for profiles CD60

Szerokość | Width: 60 [mm]
Wysokość | Height: 27 [mm]



Wieszak bezpośredni KLIK do profili CD60
Direct suspension member KLIK for profiles CD60



Wieszak bezpośredni do profili CD60
Direct suspension member for profiles CD60



Klips do profili walcowanych
Fixing clip for rolled profiles

Kątownik do profili UA
Angle for profiles UA

Szerokość | Width: 50, 75, 100 [mm]

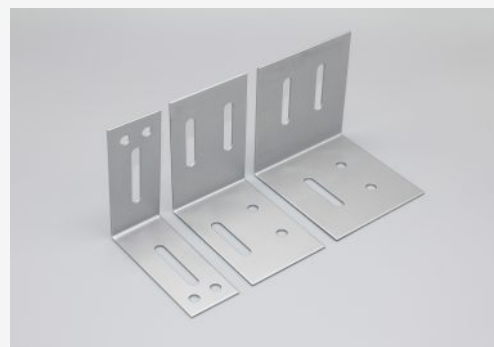

Kątownik AW do profili UA
Angle AW for profiles UA

Szerokość | Width: 50, 75, 100 [mm]

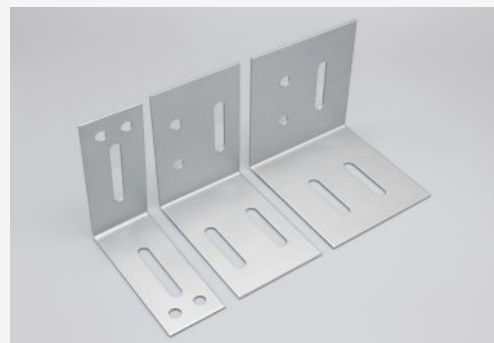

Kątownik AWG do profili UA do ścian z ugięciem
Angle AWG for profiles UA for walls with the deflection

Szerokość | Width: 50, 75, 100 [mm]



Śruba do profili UA
Bolt for profiles UA



Wieszak obrotowy ze sprężyną do profili CD60
Revolving suspension member with spring for profiles

Długość | Length: 100 [mm]





Wieszak kotwowy ze sprężyną do profili CD60
Anchor suspension member with spring for profiles CD60

Długość | Length: 100 [mm]



Wieszak do sufitów podwieszanych modułowych ze sprężyną
Hanger for modular suspended ceilings with spring

Długość | Length: 125 [mm]



Sprężyna do wieszaka dwuhakowego
Spring for two-headed suspension member



Wieszak podwójny typu hak-hak, hak-oczko
Double hanger hook-hook, hook-eyelet type

Szerokość | Width: 30 [mm]

Długość | Length: 85, 125, 170, 315, 515, 815, 1015 [mm]

Inna długość na zamówienie klienta | Other length on customer's order



Pręt mocujący z oczkiem, hakiem
Fixing bar eyelet type or hook type

Długość | Length: 125, 250, 500, 1000, 1500 [mm]

Średnica | Diameter: 4,0 [mm]

Inna długość na zamówienie klienta | Other length on customer's order

Wieszak obrotowy z noniuszem do profili CD60
Revolving suspension member with vernier for profiles CD60

Szerokość noniusza | Nonius width: 12,5; 15; 16 [mm]



Wieszak kotwowy z noniuszem do profili CD60
Anchor suspension member with vernier for profiles CD60

Szerokość noniusza | Nonius width: 12,5; 15; 16 [mm]



Wieszak do sufitów podwieszanych modułowych z noniuszem
Hanger for modular suspended ceilings

Szerokość noniusza | Nonius width: 12,5; 15; 16 [mm]



Przedłużacz do noniusza
Extender to vernier

Szerokość noniusza | Nonius width: 12,5; 15; 16 [mm]



Łącznik do przedłużacza
Connector to extender

Szerokość noniusza | Nonius width: 12,5; 15; 16 [mm]
Długość | Length: 90 [mm]





Wieszak górny noniusza
Upper suspension member of the vernier

Szerokość noniusza | Nonius width: 12,5; 15; 16 [mm]
Długość | Length: 175, 200, 300 [mm]



Wieszak górny noniusza uniwersalny
Universal upper suspension member of the vernier

Szerokość noniusza | Nonius width: 16 [mm]
Długość | Length: 175 [mm]



Wieszak dolny noniusza
Lower suspension member of the vernier

Szerokość noniusza | Nonius width: 12,5; 15; 16 [mm]
Długość | Length: 150 [mm]



Przetyczka do noniusza
Pin to extender

Średnica | Diameter: 2,8 [mm]



Element do mocowania ES płaski do profili CD45
Fixing element-flat for profiles CD45

Długość | Length: 75, 125 [mm]

Wieszak do poddaszy do profili CD45
Suspension member for profiles CD45

Długość | Length: 80, 170, 300 [mm]



Wieszak kotwowy ze sprężyną do profili CD45
Anchor suspension member for profiles CD45



Łącznik krzyżowy do profili CD45
Cross connector for profiles CD45

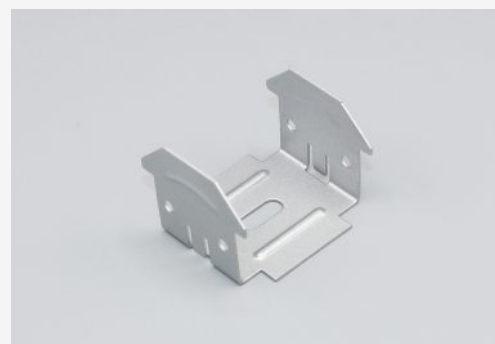

Łącznik wzdłużny do profili CD45
Longitudinal connector for profiles CD45

Długość | Length: 80 [mm]



Profil budowlany typu CD
Building profile type CD

Typ | Type: CD45, CD60

Długość | Length: 2600, 3000, 4000 [mm]



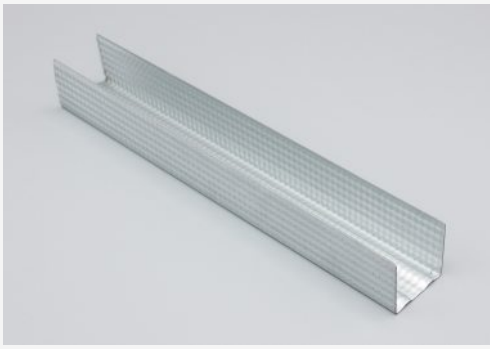

Profil budowlany typu UD
Building profile type UD

Typ | Type: UD30
Długość | Length: 3000, 4000 [mm]



Profil budowlany typu C
Building profile type C

Typ | Type: C50, C75, C100
Długość | Length: 2600, 3000, 4000 [mm]

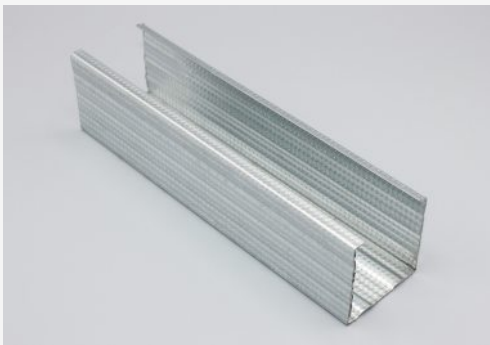

Profil budowlany typu U
Building profile type U

Typ | Type: U50, U75, U100
Długość | Length: 2600, 3000, 4000 [mm]



Profil stalowy łukowy
Steel arch profile

Długość i promień | Length and radius: według zamówienia | on individual client's order [mm]



Profil budowlany UA
Building profile type UA

Typ | Type: UA50, UA75, UA100
Długość | Length: 3000, 4000 [mm]

Narożnik aluminiowy, aluminiowy moletowany, stalowy
Aluminium, aluminium knurled, steel corner

Wymiar | Dimension: 20,5x20,5; 22x22; 23,5x23,5; 24,2x24,2;
30x30 [mm]



Narożnik aluminiowy łukowy
Aluminium corner for arch

Wymiar | Dimension: 23,4x23,4 [mm]



Półnarożnik aluminiowy, półnarożnik aluminiowy
moletowany
Aluminium half-corner, aluminium half-corner knurled

Wymiar | Dimension: 12,5x23,5; 14,2x24,2; 12,5x30; 6x30 [mm]



Narożnik aluminiowy, stalowy do mokrych tynków
Aluminium, steel corner for wet plaster

Wymiar | Dimension: 36x36; 50x50 [mm]



Narożnik aluminiowy do mokrych tynków wzmocniony
Aluminium corner for wet plaster strengthened

Wymiar | Dimension: 28x28; 32x32 [mm]





Narożnik aluminiowy specjalny
Aluminium corner special

Wymiar | Dimension: 42x42 [mm]



Listwa podtynkowa aluminiowa, stalowa
Aluminium, steel plaster moulding

Wysokość | Height: 6; 10 [mm]
Szerokość | Width: 17 [mm]



Profil cokołowy
Starting profile

Szerokość | Width: 40; 50; 60; 70; 80; 100; 120; 140; 160; 180;
200 [mm]



Profil cokołowy kątowy
Starting profile angular

Szerokość | Width: 51; 76; 101 [mm]



Profil cokołowy PCV regulowany
Starting profile PVC adjustable

Szerokość / Width: 100-140; 140-180; 180-220 [mm]
Długość | Length: 2000 [mm]

Podkładka do profili cokołowych Spacer for base profile

Grubość | Thick: 2,0; 3,0; 4,0; 5,0; 8,0; 10,0; 15,0 [mm]



Łącznik do profili cokołowych Connector for base profile

Długość | Length: 30 [mm]



Narożnik PCV z siatką do profilu cokołowego PVC corner with mesh for base profile

Szerokość | Width: 3,0; 6,0 [mm]

Długość | Length: 2500 [mm]



Narożnik aluminiowy z siatką Aluminium corner with mesh

Szerokość ramion narożnika | Width arm of the corner: 20,5×20,5;
22×22; 23,5×23,5; 24,2×24,2 [mm]

Szerokość siatki | Mesh width: 7x7; 8x8; 8x12; 10x10 [cm]

Długość | Length: 2500 [mm]

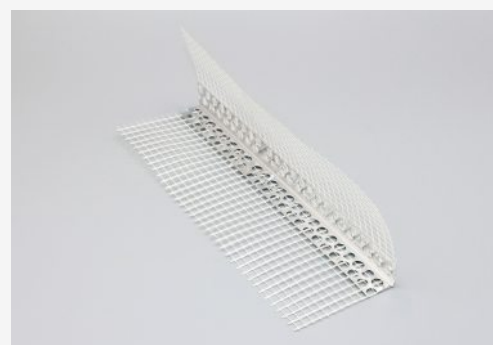

Narożnik PCV z siatką PVC corner with mesh

Szerokość siatki | Mesh width: 7x7; 8x8; 8x12; 10x10; 10x15 [cm]

Długość | Length: 2500 [mm]





Narożnik PCV uniwersalny z siatką Universal PVC corner with mesh

Szerokość siatki | Mesh width: 100x100 [mm]
Długość | Length: rolka|roll: 25; 50 [M.]

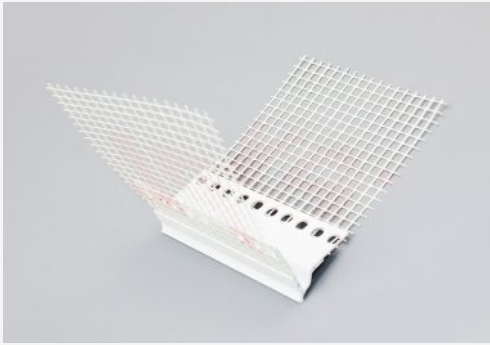

Profil okienny okapnikowy PCV z siatką PVC window profile dripnose bead with mesh

Szerokość siatki | Mesh width: 100x100 [mm]
Długość | Length: 2000, 2500, 3000 [mm]



Narożnik PCV PVC corner

Długość | Length: 2500, 3000 [mm]



Narożnik PCV łukowy PVC corner for arches

Długość | Length: 2500, 3000 [mm]



Narożnik PCV uniwersalny PVC corner universal

Długość | Length: 2500, 3000 [mm]

Narożnik PCV typu J PVC corner type J

Szerokość | Width: 9,5 12,5 15 [mm]

Długość | Length: 2500, 3000 [mm]



Profil przyokienny PCV PVC window profile

Szerokość | Width: 6; 9 [mm]

Długość | Length: 2400 [mm]



Profil przyokienny PCV z uszczelką PVC window profile with seal

Szerokość | Width: 6/3; 9/6; 9/3 [mm]

Długość | Length: 2500, 3000 [mm]



Profil przyokienny kolorowy PCV z uszczelką Colored PVC window profile with seal

Szerokość | Width: 6/3; 9/6; 9/3 [mm]

Długość | Length: 2500, 3000 [mm]

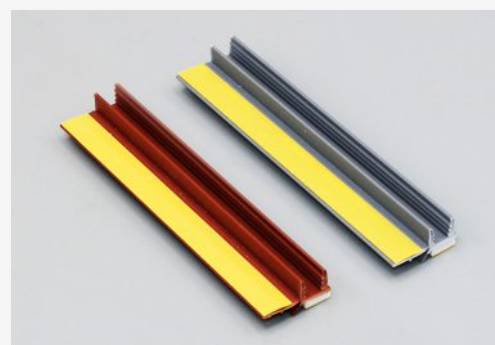

Profil przyokienny PCV z siatką PVC window profile with mesh

Szerokość | Width: 6; 9 [mm]

Długość | Length: 2400 [mm]

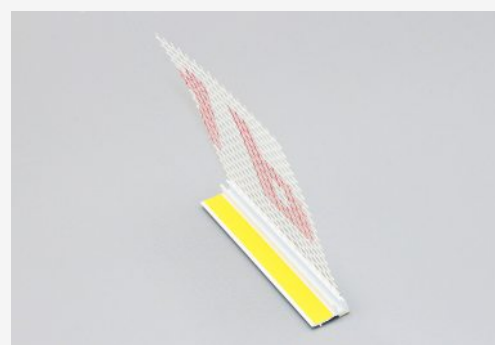

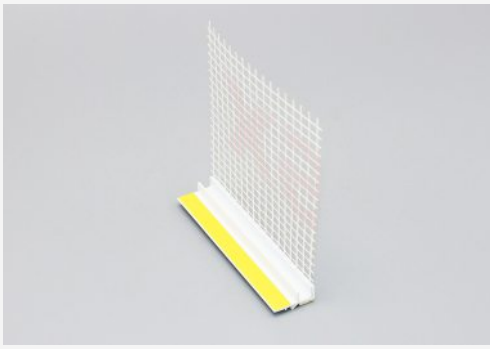

Profil przyokienny PCV z uszczelką i siatką PVC window profile with seal and mesh

Szerokość | Width: 6/3; 9/6; 9/3 [mm]

Długość | Length: 2500, 3000 [mm]

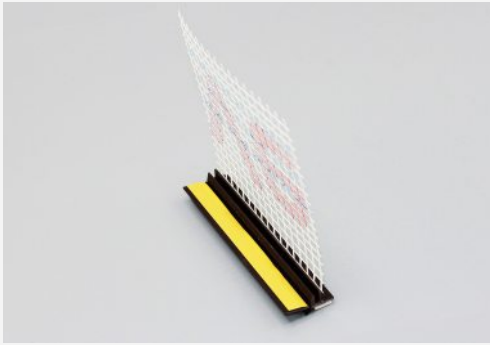

Profil przyokienny kolorowy PCV z uszczelką i siatką Colored PVC window profile with seal and mesh

Szerokość | Width: 6/3; 9/6; 9/3 [mm]

Długość | Length: 2500, 3000 [mm]



Profil PCV podparapetowy Under-sill profile PVC

Długość | Length: 200 [mm]



Profil dylatacyjny PCV z siatką: typu E - płaski, typu V - kątowy Movement bead co-extruded with mesh: E-type, V- type

Szerokość | Width: 40 [mm]

Szerokość siatki | Mesh width: 100x100 [mm]

Długość | Length: 2000 [mm]

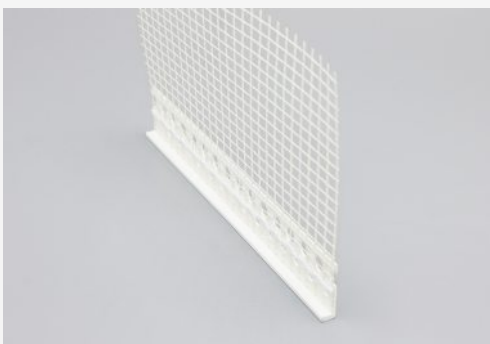

Profil PCV wykończeniowy PVC external stop bead

Szerokość | Width: 3, 6, 10, 15 [mm]

Długość | Length: 2000, 2500 [mm]

Profil PCV do boniowania / Profil PCV do bonowania z siatką
PVC profile for rustication / PVC profile for rustication

Rozmiar | Size: 10/10, 20/20, 30/20, 50/20 [mm]
Długość | Length: 3000 [mm]

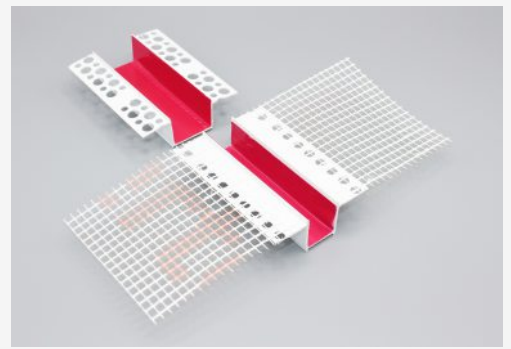

Profil PCV do boniowania z elementem traconym / Profil PCV do bonowania z elementem traconym i siatką
PVC profile for rustication with lost-part / PVC profile

Rozmiar | Size: 20/20, 30/20 [mm]
Długość | Length: 3000 [mm]

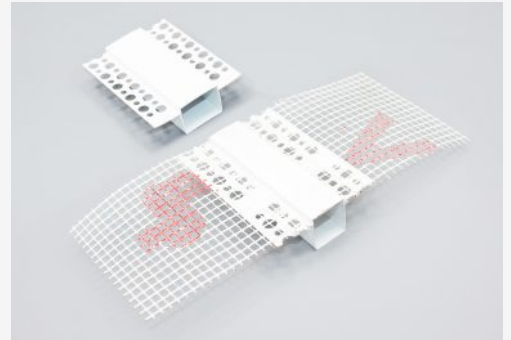

Kątownik PCV do profilu do boniowania: wewnętrzny i zewnętrzny
PVC angle for rustication profile: internal, external

Rozmiar | Size: 30/20 [mm] *kątowniki dedykowany wyłącznie do profili do bonowania z elementem traconym o szerokości 30mm | angle dedicated to rustication profile with lost-part width 30mm



Łącznik PCV do profilu do boniowania
PVC connector for rustication profile

Szerokość | Width: 10, 20, 30, 50 [mm]



Łącznik krzyżowy PCV do profilu do boniowania
PVC cross connector for rustication profile

Szerokość | Width: 10, 20, 30 [mm]





**Kołek do elewacji z trzpieniem
tworzywowym/metalowym**
Insulation dowel with plastic/metal pin

Średnica | Diameter: 8, 10 [mm]
Długość | Length: from 70 to 160 [mm]



Frez tworzywowy do styropianu
Plastic cutter for styrofoam

Średnica | Diameter: 67 [mm]



Łączniki spiralne do styropianu
Spiral connectors for styrofoam

Długość | Length: 50, 85 [mm]



Krażki styropianowe
Styrofoam roundel

Kolor | Colour: white, grey



Talerze dociskowe
Pressure plates

Średnica | Diameter: 60, 90, 140 [mm]

Samoprzylepna taśma akustyczna
Self-adhesive acoustic tape with mesh

Szerokość | Width: 30, 50, 75, 95 [mm]

Długość | Length: 30 [mb | lm]



Samoprzylepna taśma z włókna szklanego
Fiberglass self-adhesive tape for rustication with lost-part and mesh

Szerokość | Width: 48 [mm]

Długość | Length: 20, 45, 90 [mb | lm]



Aluminiowa kłapa rewizyjna z wypełnieniem z pojedynczej/podwójnej płyty gips-kartonowej

Wysokość | Height: 12,5; 25 [mm]



Aluminiowa kłapa rewizyjna pod płytki
Aluminium revisory trap for tiles

Wysokość | Height: 25 [mm]

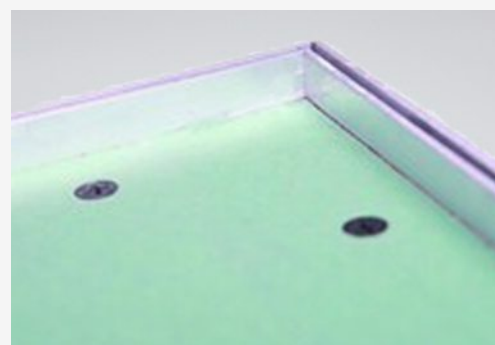

Wspornik pod umywalkę
Under-basin bracket

Szerokość | Width: 410 [mm]

Długość | Length: 554[mm.]



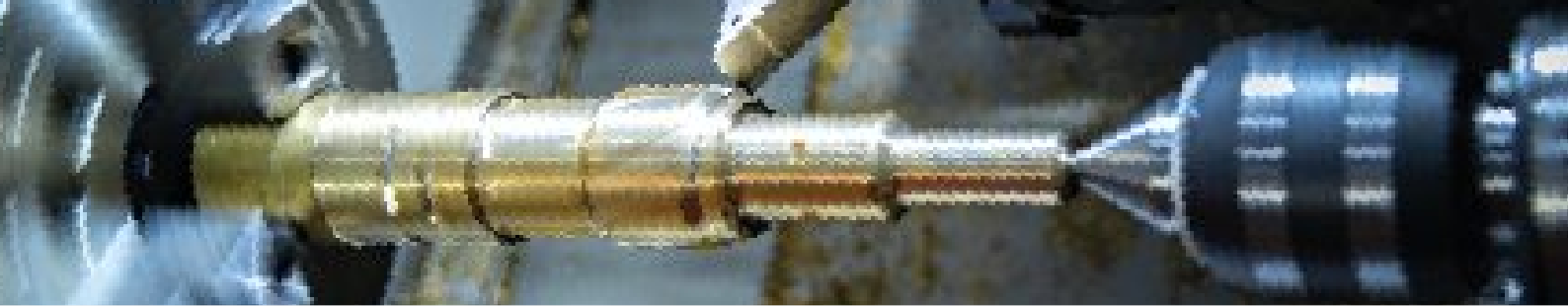

**MATERIAŁY BUDOWLANE
SYSTEMY ODGROMOWE
KONSTRUKCJE ENERGETYCZNE I BUDOWLANE
CZĘŚCI DO MASZYN PRZEMYSŁOWYCH**

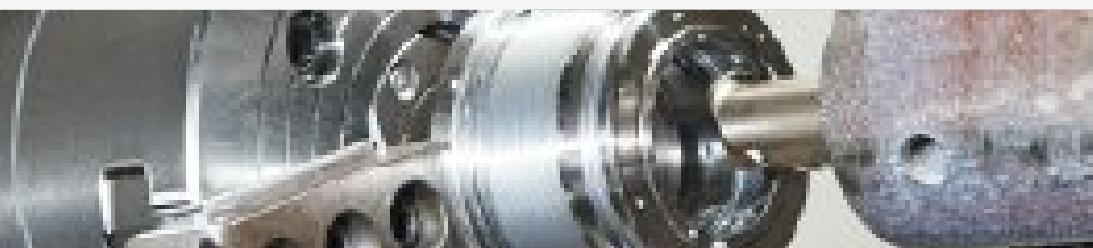

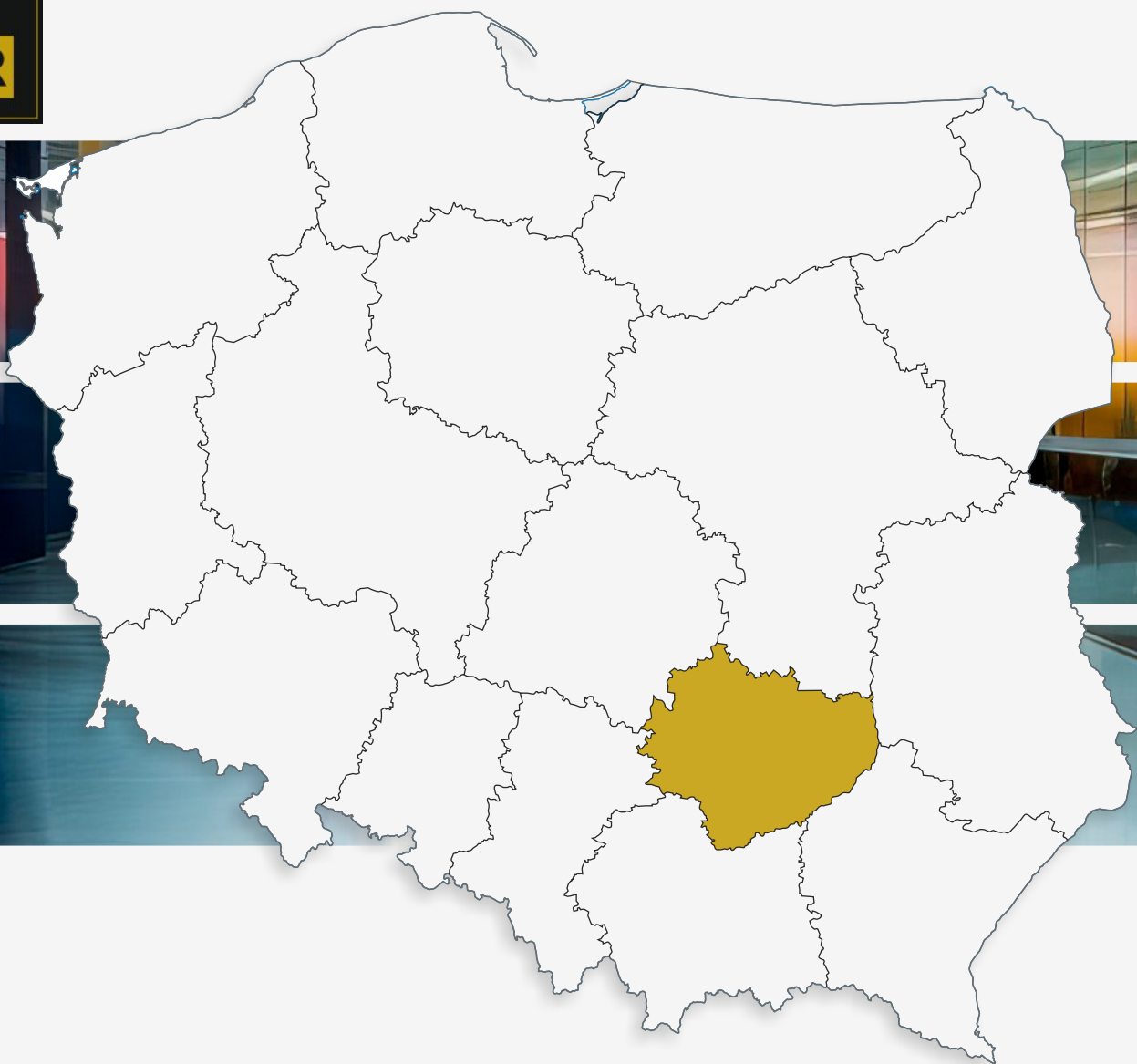

DANE KONTAKTOWE

ZPU DELKAR

Zgórsko, ul. Leśna 18
26-052 Nowiny - Polska

DZIAŁ KRAJOWY

+48 573 786 149
+48 789 123 790

DZIAŁ EKSPORTU

+48 533 808 512
+48 530 855 564